

Technical specifications

QIS 95

Voltage: 400/230 V

Frequency: 50HZ



Genset Image for illustration purposes only

TECHNICAL INFORMATION

Standby Power (ESP)	kVA	95
	kW	76
Prime Power (PRP)	kVA	85
	kW	68
Mechanical structure	Soundproofed	
Engine	CUMMINS 6BT5.9-G2	
Alternator	MECC ALTE ECP34-1S	
Control card	DEEP SEA 4620	
Measures (L x W x H)	mm	2.900 x 1.090 x 1.685
Empty weight	kg	1.774
Fuel tank	L	215
Acoustic pressure, LpA	dB(A) a 7	70
Acoustic power LwA	dB(A)	96

Voltages	Prime Power (PRP)		Standby Power (ESP)	
	(kVA)	(kW)	(kVA)	(kW)
380/220	85	68	95	76
400/230	85	68	95	76
415/240	85	68	95	76

Notes:

PRIME POWER: Electrical power data available at a variable load without limits of hours per year. An overload of 10 % is allowed for 1 hour of every 12. In accordance with ISO 8528/1 (2005) – PRP

STANDBY POWER: Electrical power data at variable load in an emergency in accordance with standard ISO 8528/1 (2005) – ESP. Overloads of emergency power are not allowed.

The standard reference conditions are: 25 °C, 100 kPa and 30% relative humidity. Gasoil density: 0.85 g/cm3. Gasoline density: 0.68 g/cm3.

■ INDEX

General description
Engine
Alternator
Bedplate
Soundproofed canopy
Electric Panel
ATS
Dimensions and Weight
Performance class
Regulation
Annex: Drawings

Grupos Electrógenos Europa, S.A. is a certified company with ISO 9001, ISO 14001, OHSAS 18001 and PECAL

We reserves the right to modify any characteristic of their equipment without prior warning.

Photographs representing the product range, while able to include options.

Weight and dimensions of a standard generator set.

Non-contractual document

Central Offices:

Polígono Industrial Pitarco II; Parcela 20

50450 Muel (Zaragoza) Spain

Tel.: +34 976 14 54 32

Fax: +34 976 14 54 31

info@gesan.com

After-sales Department:

Customer service: +34 976 14 54 33

Spare parts: +34 976 14 54 34

GENERAL DESCRIPTION

Generator set for automatic operation due to a grid failure, including the electrical operations panel and soundproofing. Start-up of the generator set will be carried out when a failure in the grid power supply is detected. Once the generator set has stabilized, a signal is sent to the switching panel to switch the grid position to generator set. When the grid power supply return is detected, a command is sent to the switching to switch to the generator set position of the grid. The generator set shuts-down after the applicable cooling period has elapsed.

ENGINE

Cummins diesel engine, with turbo, with direct injection and Electronic regulation of the engine.

Engine brand	CUMMINS	Bore (mm)	102
Model	6BT5.9-G2	Stroke (mm)	120
R.P.M.	1.500	Compression ratio	16,5:1
Net power (kWm)	87	Type of regulation	Electronic
Fuel	Diesel	Europe exhaust emission	EU0
No. of cylinders	6 L	EPA exhaust emission	EPA0
Engine Capacity (c.c.)	5.900		

Cooling System

Cooling of the sleeves using cooling fluid comprised of water and glycol at 50% in a closed circuit driven by the engine pump.

Engine driven exhaust fan, radiator and expansion tank; original from the engine manufacturer.

The circuit is completed with the cooling purge system towards the outside of the bedplate and protections of all running surfaces

Cooling type	Water
---------------------	-------

Lubrication System

Gear pump lubrication system driven by the engine and with original engine manufacturer lubricant filtering system.

It is completed with the oil purge system towards the outside of the baseframe.

Oil capacity (l)	14,2
-------------------------	------

Air intake system

Air intake system for combustion with turbo, filtering device and filter change indicator; originals from the engine manufacturer.

Intake air flow (m³/min)	6,6	Air inlet filter type	Medium
--------------------------------------------	-----	------------------------------	--------

Exhaust System

Interior and exterior aluminized steel exhaust silencer.

T^a gas emission (°C)	540	Outlet diameter (")	4
Gas flow (m³/min)	18,3	Inlet diameter (")	3
Number of exhaust	1	Atenuation (dB(A))	26

Start system

Start system that uses an electrical motor, battery and battery charge alternator that is driven by the engine itself. The start motor and the battery charge alternator are originals from the engine manufacturer.

Starter voltage system (V)	24	Battery type	2 x 12V 45Ah - 400A
-----------------------------------	----	---------------------	---------------------

Fuel supply system

Fuel intake system original from engine manufacturer with filter.

Fuel tank capacity (L)	215
-------------------------------	-----

Fuel consumption panel (range according to the standard configuration)

Load	Prime Power (PRP)		Standby Power (ESP)	
	(l/h)	Range (h)	(l/h)	Range (h)
25%	5,8	37		
50%	10	22		
75%	14,5	14,8		
100%	19,3	11,1	22	10

ALTERNATOR

Mecc Alte alternator with 4 poles, with a lifetime lasting greased bearing, H class insulation, without brushes, 2/3 coil and AVR (Automatic Voltage Regulator)

Protection of all the windings by means of 2-part high quality polyester resin impregnation. The stator windings receive a double impregnation. Final finish with a coat of EG43 varnish.

Excitation system with MAUX auxiliary winding with overload capacity 3 times the nominal current for 20 s.

Joining of engine and alternator through flexible disc coupling.

Regulations:

- CEI 2-3
- IEC 34-1
- EN 60034-1
- VDE 0530
- BS 4999-5000
- CAN/CSA-C22.2 No14-68-No100-95
- ISO 8528:3

Low wave distribution:

- THC < 4%
- THD < 4%
- THF (IEC) < 2%
- TIF (NEMA) < 40

Incorporates electromagnetic emissions suppressor in accordance with standard VDE 0875, class K.

Brand	MECC ALTE	Voltage Stability	±1%
Model	ECP34-1S	Performance at 75% p.f. 0.8 (%)	92
Alternator Power (kVA)	95 / Standby (SB27)	Performance at 100% p.f. 0.8 (%)	92
Number of wires	12	Direct subtransient reactance X''d (%)	7,4
IP Alternator	IP 21	Subtransient time constant, T''d (ms)	5,8
Excitation system	MAUX	Zero sequence reactance, Xo (%)	3,6
AVR model	DSR	Short-circuit ratio, Kcc	0,5

▪ BEDPLATE

The engine-alternator set is coupled to the base frame by means of anti-vibration shock mounts. The fuel tank is integrated and welded to the base frame. It has a drainage plug, wide cleaning cover and filler connection with plug. Includes level sensor with low fuel alarm signal that indicates the amount of fuel available in the tank to the electrical panel.

▪ SOUNDPROOFED CANOPY

Soundproof generator set finish using polyester dust paint. It is lined inside with a noise-absorbing material made of mineral wool. It also has an emergency shutdown pushbutton that is accessible from the outside.

▪ ELECTRIC PANEL

Electrical panel integrated in the generator set with digital control plate.

Has a ABB brand single-pole circuit breaker, manually actuated, with thermal-magnetic protection against overloads and short-circuits.

Battery charger	DSE 9255 - 24V 5A
------------------------	-------------------

Has a DEEP SEA battery charge maintainer, designed to be permanently connected to the battery and maintains it charged to its maximum capacity.

Has no moving parts. The charger switches to floating mode when the charge is complete

Control Card

DEEP SEA control plate, DSE 4620 with grid monitor that starts-up the generator set when it detects a failure in the electrical power supply from the grid and sends a signal to the switching panel to switch from the grid position to the group position. Once the power supply has been re-established, it sends an order to the switching panel to transfer the generator set power to the grid and shuts-down the generator set once it has cooled down. It also starts-up the generator set using an external signal.

Also, control plate DSE 4620 checks a large number of parameters of the generator set which allows it to display information, statuses and alarms. If required, it will shutdown the generator set: Due to high coolant fluid temperature, low oil pressure, low coolant fluid level, etc.

Includes a LCD screen with lighting, 2 navigation menu buttons, independent operational mode buttons, and alarms and status indicating LEDs.

Communications via USB, and Completely configurable using a PC in Windows environment and free Scada type software in real time.

Includes reading and displaying of parameters with RMS values, real time clock, events history log up to 15 events and programming of alarms, events, start-ups and shutdowns.

Operating modes: START-UP, SHUTDOWN, AUTO, MANUAL AND TEST.

Generator

- Generator voltage (L-N)
- Generator voltage (L-L)
- Generator frequency
- Generator current
- kW
- kVA
- kWh
- kVAh
- Power factor

Grid

- Grid voltage (L-N)
- Grid voltage (L-L)
- Grid frequency

Engine

- Turn speed
- Cooling fluid temperature
- Oil pressure
- Hour meter
- Battery voltage
- No. of start-ups
- Fuel level

Protections

- Start-up fault (generator set shutdown)
- High coolant temperature (alarm and generator set shutdown)
- Low oil pressure (alarm and generator set shutdown)
- Low fuel level (alarm)
- Low cooling fluid level (generator set shutdown)
- Overload (alarm and generator set shutdown)
- Battery voltage high (alarm)
- Battery voltage low (alarm)
- Battery charge alternator failure (alarm)
- Generator low frequency (alarm and shutdown)
- Generator high frequency (alarm and shutdown)
- Generator low voltage (alarm and shutdown)
- Generator high voltage (alarm and shutdown)
- External emergency shutdown (shutdown)
- Engine overspeed (shutdown)
- Maintenance interval (alarm)



■ ATS

Optional cabinet for switching between the grid and the generator set by means of a Socomec brand motorized switch with an integrated mechanical and electrical interlocking device.

Allows for the padlock locking function. Includes a Manual / Automatic mode selector and emergency manual control.

Safety switching for isolating the loads. High dynamic resistance against short-circuits.

Position indicator with fully visualized cut-off. Stable positions not affected by changes in voltage and mechanical vibrations. External electrical control of the positions and test sequences.

High number of operations. IP54 protection. Connections: Lower/lower.

ATS	4P 160A 160-333V L-N CCM
------------	--------------------------

■ DIMENSIONS AND WEIGHT

Length, L (mm)	2.900
Width, A (mm)	1.090
Height, H (mm)	1.685
Weight (kg)	1.774

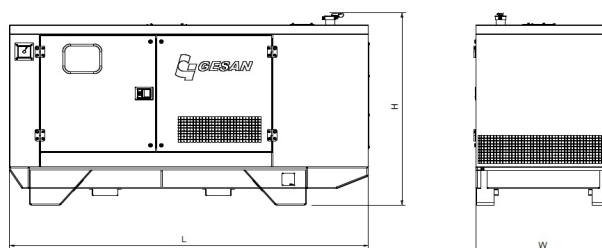

■ PERFORMANCE CLASS

Execution class in accordance with ISO 8528/5 (2005) taking into account the behaviour of the generator set in a permanent mode of operation with different load levels, as well as in a temporary mode of operation due to shocks in the load.

Performance class	G2
--------------------------	----

■ REGULATION

The generator set has a CE Marking that includes the following directives:

- 2006/42/CE Machine Safety.
- 2006/95/CEE Low Voltage.
- 2004/108/CE Electromagnetic compatibility.
- 97/68/CE Gases and contaminating particles emissions.
- 2005/88/CE Noise emissions of machines outdoors in soundproof generator sets.

Applicable international regulations:

- ISO 8528
- ISO 3046
- BS 5000
- IEC 60034

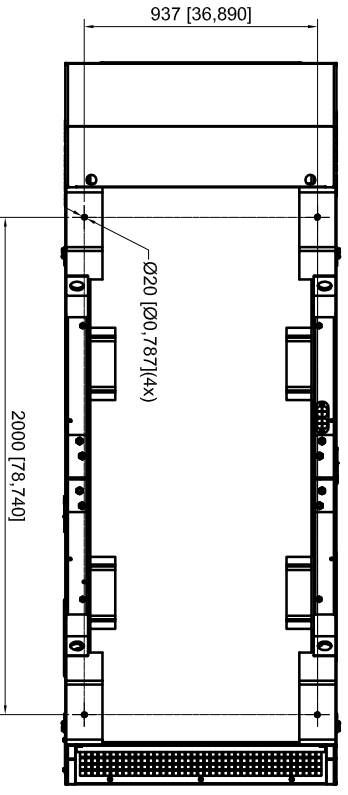
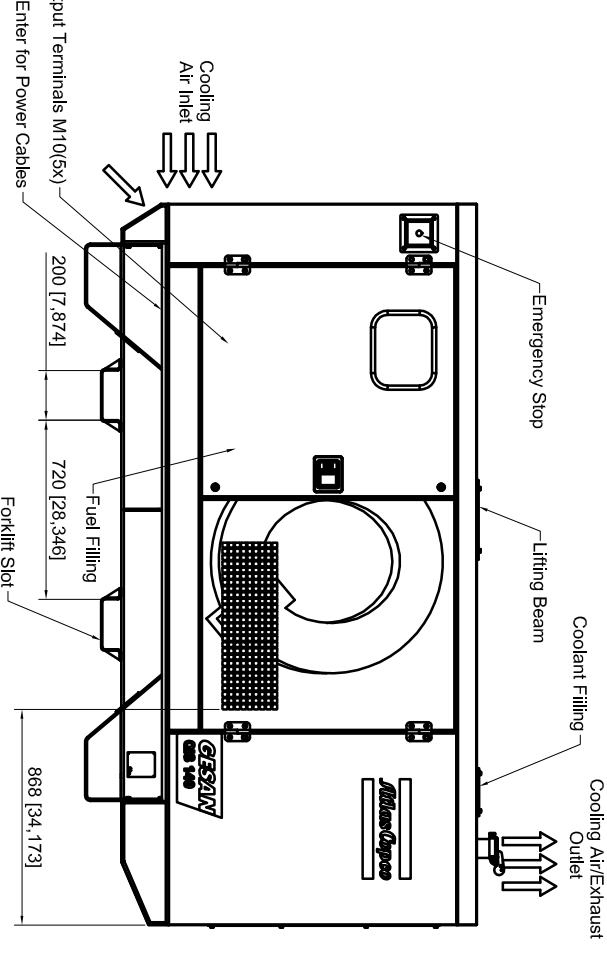
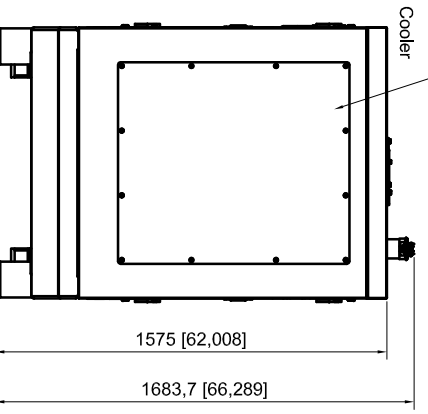
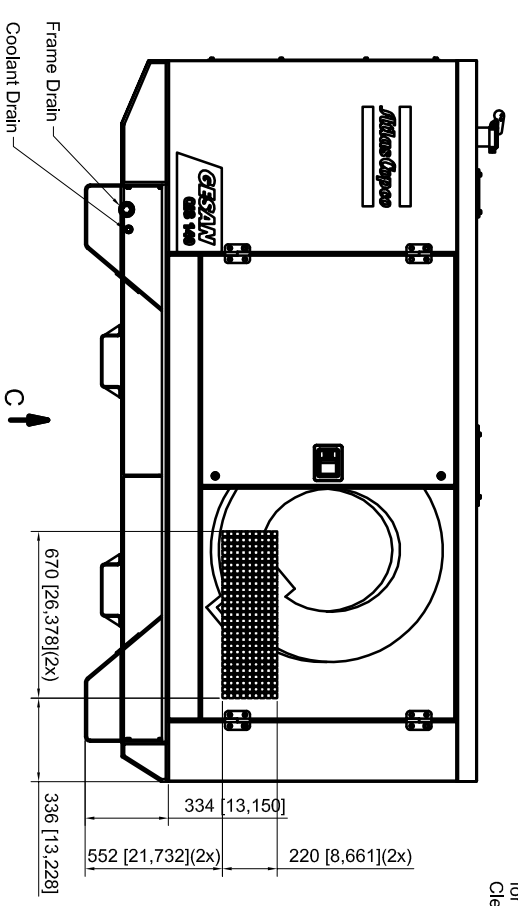
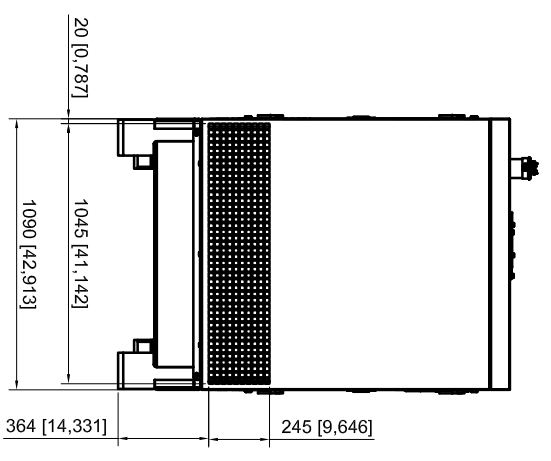
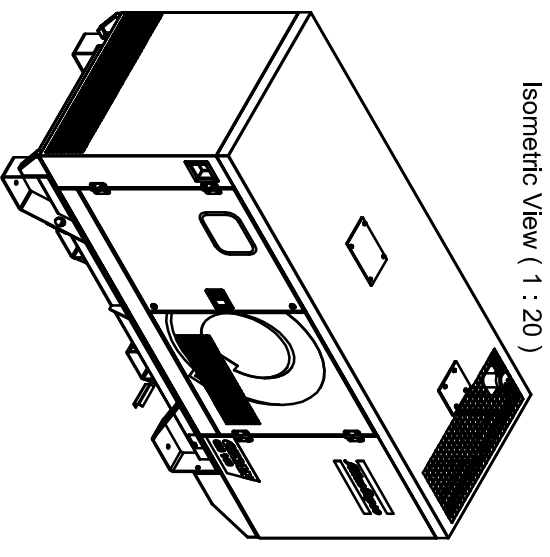
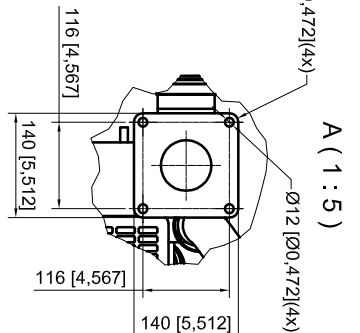
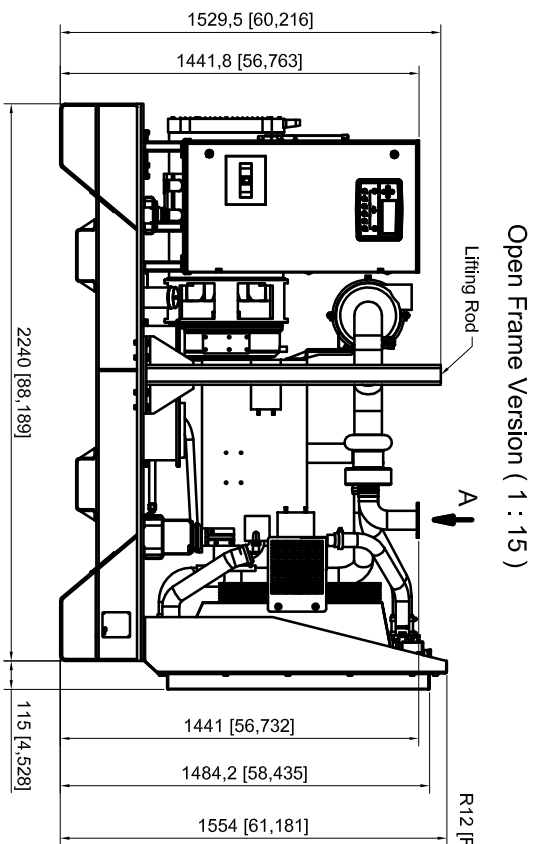
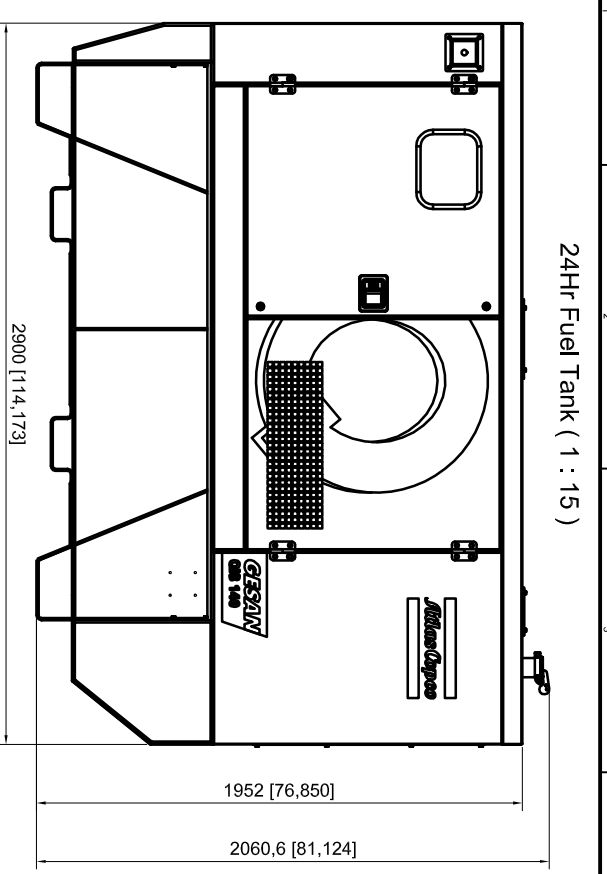

C (1 : 15)

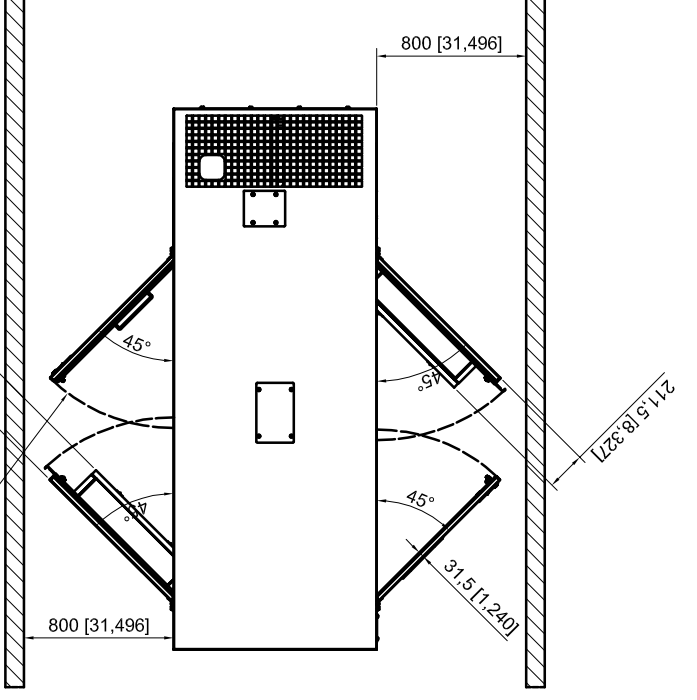

Unit Model	Net Mass	Xz		Yz		Weight Mass	Xz		Yz	
		Kg/lbs	mm/inch	mm/inch	Kg/lbs		mm/inch	mm/inch	mm/inch	mm/inch
Open Frame	QIS 95	1345/2965	1149/45	555/22	1566/3452	1199/47	555/22			
	QIS 115	1395/3075	1164/46	555/22	1616/3562	1214/48	555/22			
With Canopy	QIS 95	1529/3371	1149/45	555/22	1800/3968	1199/47	555/22			
	QIS 115	1579/3481	1164/46	555/22	1850/4079	1214/48	555/22			
24Hr Fuel Tank	QIS 95	2059/4539	1149/45	555/22	2280/5026	1199/47	555/22			
	QIS 115	2009/4429	1164/46	555/22	2330/5136	1214/48	555/22			
	QIS 140	2147/4733	1179/46	555/22	2380/5246	1229/48	555/22			

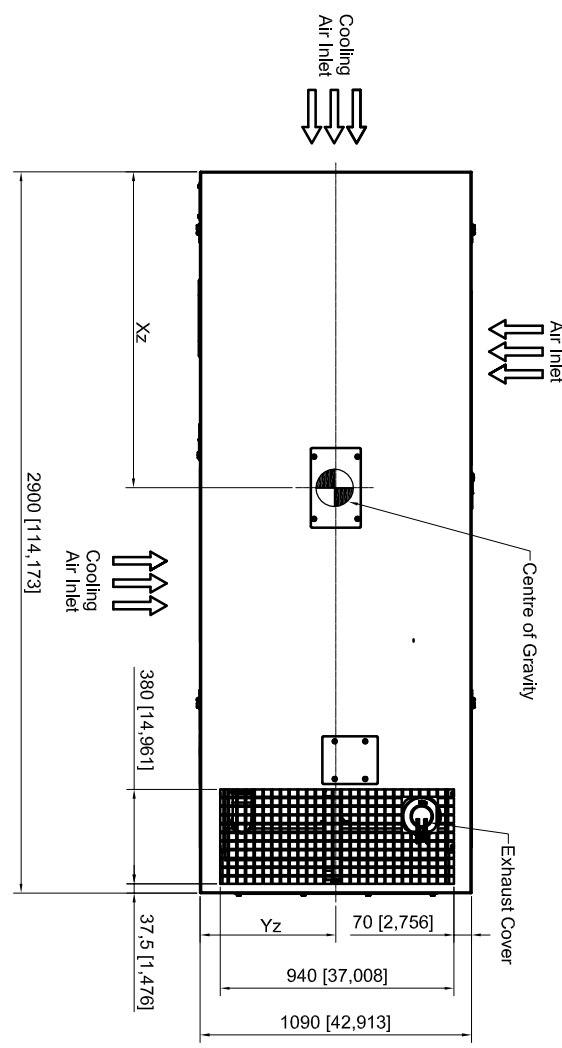

Notes:
- □ = Dimensions are in inches.

(Net Mass = Without oil, coolant, fuel and dry batteries)

1625090000-M1
Paper 3D model

0030
Ed. Version 3D

ATLAS COPCO STANDARD CLASS
Name
Dimension Drawing
Material
Treatment
Scale
Partly
Drawing owner
WIX

QIS BOX C
Not Applicable
1:15
WIX

9829390020